

# **IN-DEPTH MANUAL**

**INTELLIGENT DIGITAL ENHANCED COMMUNICATIONS SYSTEM**

# **TS-870S**

**HF TRANSCEIVER**

# **KENWOOD**

# CONTENTS

---

## DSP (Digital Signal Processor)

<b>Introduction</b>	.....	<b>4</b>		
<b>1. IF DSP Processing</b>	.....	<b>5</b>		
1. IF filters	.....	5		
<b>2. Transmission</b>	.....	<b>7</b>		
1. SSB	.....	7		
2. CW	.....	7		
3. FSK	.....	7		
4. AM	.....	8		
5. FM	.....	8		
6. Microphone gain control	.....	8		
7. Speech processor	.....	9		
8. VOX	.....	9		
<b>3. Reception</b>	.....	<b>9</b>		
1. SSB	.....	9		
2. CW	.....	10		
3. FSK	.....	10		
4. AM	.....	10		
5. FM	.....	10		
6. Digital AGC	.....	11		
<b>4. Noise &amp; Interference Reduction</b>	.....	<b>12</b>		
1. Noise reduction	.....	12		
2. Auto notch	.....	13		
3. Beat canceller	.....	13		
<b>5. RX Circuitry</b>	.....	<b>14</b>		
1. Large input protector	.....	14		
2. External receiver output terminals & signal splitter	.....	14		
3. Attenuator	.....	14		
4. Band-pass filters	.....	14		
5. Pre-amps	.....	15		
6. Mixer	.....	15		
7. Roofing filter	.....	15		
8. 2nd/3rd IF filters	.....	15		
9. IF amps	.....	15		
<b>6. TX Circuitry</b>	.....	<b>15</b>		
1. TX gain control	.....	16		
2. TX AGC	.....	16		
3. CW rise time	.....	16		
			<b>7. Automatic Antenna Tuner</b>	.....16
			<b>8. DRS</b>	
			<b>(Digital Recording System)</b>	.....17
			<b>9. Electronic Keyer</b>	.....18
			<b>10. Auto Mode</b>	.....19
			<b>11. Data Communications</b>	.....20
			<b>12. Computer Control</b>	.....20
			<b>13. Connecting to a Linear</b>	
			<b>Amplifier</b>	.....21
			<b>14. Menu System</b>	.....21
			<b>Appendix</b>	
			A/D & D/A converters	.....24
			Why a 24-bit DSP?	.....24
			Aliasing	.....25
			<b>Optional Accessories</b>	.....27

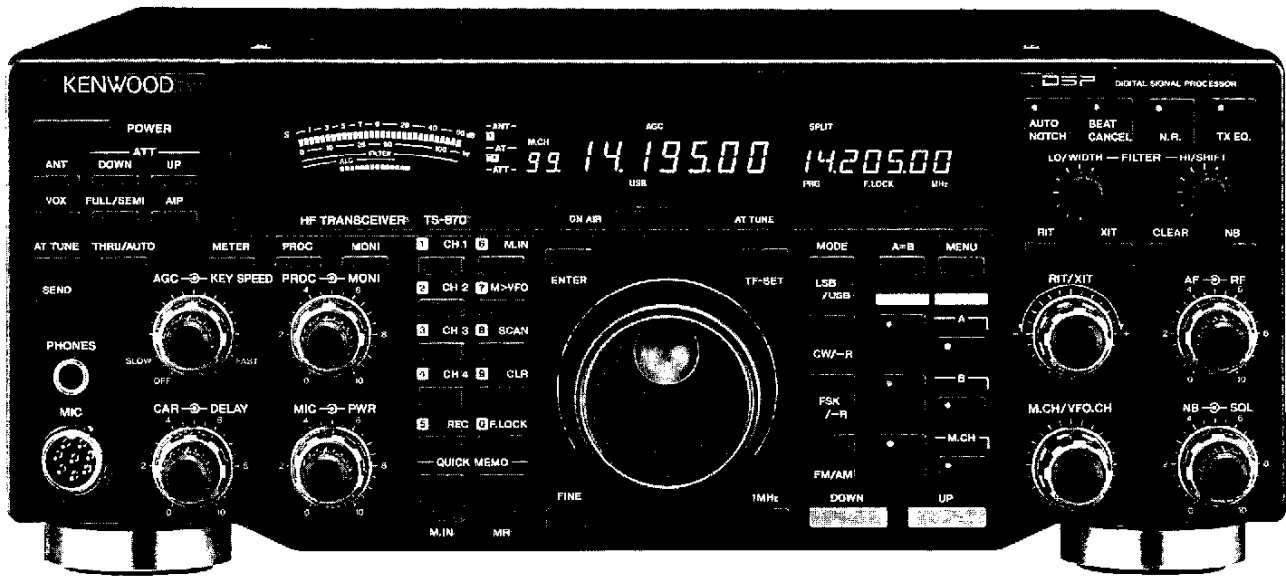

HF TRANSCEIVER WITH NEXT GENERATION IF-STAGE DSP

# TS-870S

## INTELLIGENT DIGITAL ENHANCED COMMUNICATIONS SYSTEM

Having developed the TS-950 Series — the world's first transceivers for Amateur Radio to be equipped with digital signal processors (DSP) — Kenwood has continued to be in the forefront of advances in communications technology. Introduced here is the TS-870S, a new HF transceiver that will further expand the envelope of DSP technology.

# DSP (Digital Signal Processor) Introduction

Instead of the 16-bit DSPs used previously, this new model features a pair of powerful Motorola DSP56002FC40 24-bit processors, offering an impressive performance of 20MIPS (20 million instructions per second).

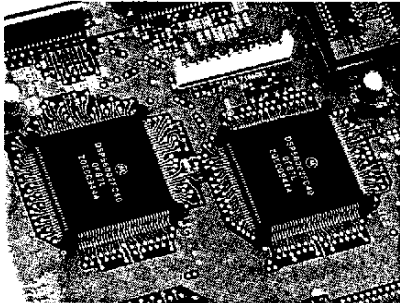

DSP

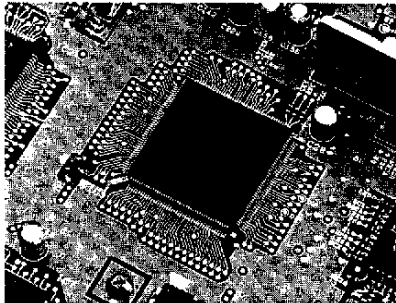

Gate array

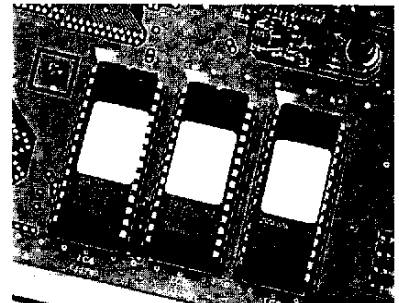

ROM

Among the benefits of adopting such high-speed, high-performance DSPs are digital signal processing right from the IF stage, as well as the sort of noise reduction and beat cancellation for which DSPs are renowned.

The DSPs operate at 40MHz. For this, the 20MHz clock signal is taken from the TS-870S's standard oscillator and then doubled internally via PLL. The instruction cycle is, however, half of this: 20MHz.

The two DSPs exchange data via a connecting gate array device with approximately 10,000 gates and internal dual-port RAM — a configuration that ensures high-performance processing. In addition, the gate array device features interfaces for the A/D and D/A converters as well as a bus switching capability.

As for the memory required by the DSPs for numerical calculation, each is provided with 512 x 24-bit RAM for program use and 256 x 24-bit RAM for data use. Externally there are three 32k x 8-bit ROMs for storing filter data and programs, and one high-speed 8k x 24-bit SRAM chip for signal processing. External ROM and RAM chips are connected to the main DSP. When necessary, the sub DSP accesses the main DSP's ROM and RAM using the bus switching capability of the gate array device that connects them. The timing of this bus switching is controlled by the EPM7032LC44, a semi-custom IC (CPLD).

With a 70-nanosecond access time, the ROM chips offer fast performance. Because of this, there is less waiting time and correspondingly less impact on the DSP's processing speed during memory access.

The SRAM chip, designed exclusively for DSP use, has an astonishing 25-nanosecond access time. This means that frequently accessed RAM is effectively "zero wait" for the main DSP, allowing it to operate at its maximum potential.

With the configuration outlined above, the DSP-equipped TS-870S is able to offer such new functions as IF filtering, all-mode DSP detection — including AM/FM detection — noise reduction, auto-notch, and a beat canceller. The work of many other circuits has been taken over by the DSPs.

Let's now look at some of these features in detail.

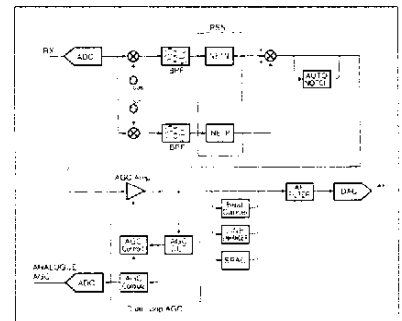

• Internal DSP operation during CW/SSB receive

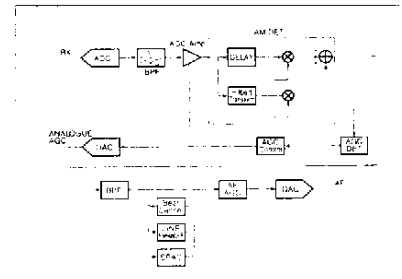

• Internal DSP operation during AM receive

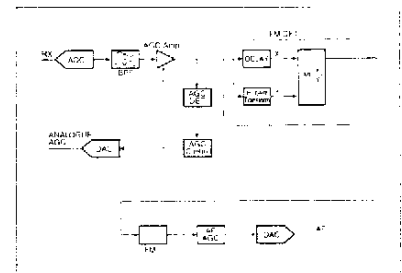

• Internal DSP operation during CW/SSB receive

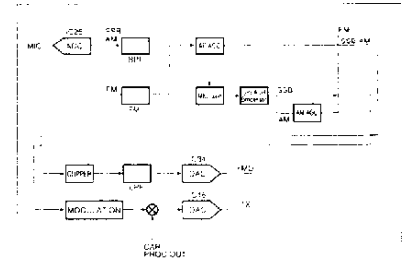

• Internal DSP operation during AM receive

# 1. IF DSP Processing

The TS-950 Series and the DSP unit (DSP-100) made available for the TS-850 were both designed to provide high audio quality when transmitting and receiving, thanks to low-distortion modulation and detection. This was achieved by employing DSPs for part of the IF processing, as well as for modulation during transmit and digital detection during receive.

Thanks to more advanced DSP design and new algorithms, however, the TS-870S performs all IF processing — including high-precision IF filtering and AGC processing for RX signal level control — using DSPs.

## 1. IF filters

### 1) Characteristics of IF digital filters

By turning over the entire IF stage to DSPs, one point on which the TS-870S differs totally from previous models is that it features (as standard) no fewer than 237 IF filters with extremely sharp characteristics. This is because digital filters suffer none of the performance degradation or inconsistency that can be traced to the devices that comprise conventional circuitry.

In addition to switching between numerous IF filters or between narrow and wide bandwidths, previous HF transceivers used variable bandwidth functions such as slope tuning and VBT with a combination of filters, as well as IF shift (local variation either side of a filter).

With the TS-870S, however, slope tuning and bandwidth width/shift control are implemented by switching between numerous digital filters. Thus there is no longer any need to install optional filters, as has been the case with HF transceivers until now. The digital filters installed are listed in Table 1 by mode.

On the TS-870S the filter with the narrowest bandwidth is the 50Hz filter for CW use. In the case of conventional analog IF filters, it is very difficult to create such a narrow filter, and even if it were possible to create one, filter loss would decrease sensitivity, and distortion would arise as a result of the filter's group delay characteristics; consequently, the quality of reception would be too poor for the filter to be of any practical use. In contrast, there is no loss with digital filters, so there is no decrease in sensitivity. As for group delay characteristics, Kenwood has made use of the considerable DSP technology developed since the TS-950SD to design filters with minimal group delay distortion — even for IIR (infinite impulse response) filters which have such sharp characteristics. We have thus created IF narrow filters which are sharper than any conventional analog IF filter or audio processing DSP.

As a means of suppressing the group delay distortion of narrow filters, it is possible at the design stage to employ FIR (finite impulse response) filters or to correct the filters' group delay characteristics. But the signal delay of an FIR filter or of a filter with corrected group delay characteristics is longer than that of an uncorrected filter, so they are not suitable for IF use. Since group delay distortion is barely perceptible to the human ear, there is no need to eliminate it entirely. What we have done with the TS-870S IF filters is, by combination with a PSN (phase shift network) approach, to ensure that group delay distortion is too low to cause any conceivable problem.

FIR filters have been used in the IF stage for AM and FM reception. While it may seem to contradict what has been said above, this has been done so as to reduce IF filter distortion and make efficient use of the DSP's detection capability in AM and FM modes. Group delay distortion in SSB and CW modes has no effect on amplitude, but in AM (detuned) and FM modes group delay distortion appears

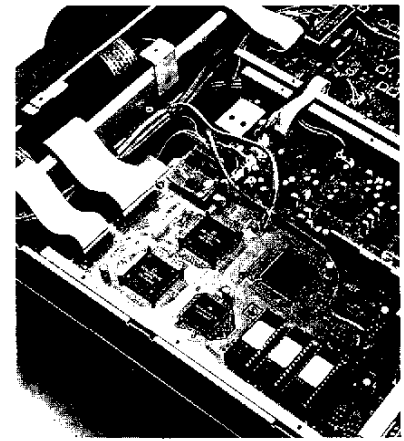

• IF circuitry

Table 1: Digital filters

<b>SSB mode</b>	Operates as slope tune capable of independently varying high-cut and low-cut frequencies. It is possible to eliminate interference with minimal effect on audio quality. <ul style="list-style-type: none"> <li>• High-cut frequencies (kHz): 12 stages (default: 2.8kHz)</li> <li>• Low-cut frequencies (kHz): 10 stages (default: 300Hz)</li> </ul>
<b>CW mode</b>	Operates as VBT capable of varying pass bandwidth or as SHFT for moving the position of the central frequency. In either case, it is possible to avoid adjacent signals. <ul style="list-style-type: none"> <li>• WBT — pass bandwidth (kHz): 5 stages (default: 1000Hz)</li> <li>• SHFT — central frequency position (kHz): 13 stages (default: 3000Hz)</li> </ul>
<b>FM mode</b>	Operates as VBT capable of varying pass bandwidth. <ul style="list-style-type: none"> <li>• WBT — pass bandwidth (kHz): 6 stages (default: 1400Hz)</li> </ul>
<b>AM mode</b>	Operates as slope tune capable of independently varying high-cut and low-cut frequencies. By adjusting the IF pass bandwidth, the high-cut frequency eliminates interference thus making it possible to enjoy clear reception of short-wave broadcasts. <ul style="list-style-type: none"> <li>• High-cut frequencies (kHz): 5 stages (default: 8kHz)</li> <li>• Low-cut frequencies (kHz): 4 stages (default: 100Hz)</li> </ul>
<b>FSK mode</b>	Operates as VBT capable of varying pass bandwidth and eliminating interference. <ul style="list-style-type: none"> <li>• Pass bandwidth (kHz): 4 stages (default: 1500Hz)</li> </ul>

as amplitude distortion. Narrow-bandwidth FIR filters for SSB and CW use are not suitable as IF filters because their signal delay would be too long, but it is possible to arrange for the signal delay to be within an acceptable range for AM and FM use.

In AM mode, using 12kHz and 14kHz wide filters, audio quality is of the highest level found in any transceiver. You can enjoy broadcasts with breathtaking clarity.

In FM mode, since even-order distortion is reduced whether or not bandwidth is narrowed, even when selecting a narrow filter for reception of a weak signal — as in data communications, for example — the error rate is kept to an acceptable level.

## 2) Differences from AF filters

When AF filter bandwidth is made narrower than that of the IF filters, should there be an interfering signal between the cutoff frequencies of the AF and IF filters of the kind that can be attenuated by the AF filters but not by the IF filters, the interference can be made inaudible by inserting a sharp AF filter.

What then happens to the target signal when this interfering signal is made to disappear? If the target signal is stronger than the interfering signal, or even slightly weaker, the elimination of the latter will enable excellent reception. But if the target signal is significantly weaker than the interfering signal, the result may be that nothing at all is heard. This phenomenon arises because the receiver's AGC tries to maintain a set level for the signals — including both target signal and interfering signal — within the IF filters' bandwidth.

When the target signal and interfering signal are at the same level, it is acceptable if the target signal level is halfway (3dB) down, but if the interfering signal is 50dB stronger than the target signal, the target signal level will also be reduced 50dB below the interfering signal. Consequently, if AF filters are used to suppress an interfering signal, there will be nothing left to listen to. Trying to raise the volume will not be successful and, since the IF gain will have dropped by 50dB, deteriorating S/N may mean that everything is swamped in noise.

When filters with the same characteristics are employed in both AF and IF stages, it is the AF filter that will produce an audibly clearer result; this is the advantage of AF filters. In the IF stage, the AGC works to keep the reception level within a range, and thus the filter appears to function less crisply than its AF equivalent. Also, because the signal delay in the IF filter affects the AGC's attack time, filters which have a long signal delay — such as FIR filters — cannot be used.

## 3) Combinations of AF filters and IF filters

AF filters are effective as support for IF filters, but in difficult conditions — as when there is a great deal of interference — the sharp characteristics of IF filters are essential. If the IF filters are sharp, the AGC functions only with respect to the target signal and, unlike the situation with AF filters, the target signal does not become inaudible if it is weak. By efficiently combining the different characteristics of IF filters and AF filters one can create a high-performance filter that offers excellent interference reduction characteristics.

In the TS-870S, AF filters are used together with IF digital filter slope tuning and width/shift control. Filter characteristics are sufficient with just the IF digital filters, but AF filters have been incorporated so as to improve the characteristics of the AGC, etc.

### IIR filters

Digital filters can be divided into two general groups: IIR and FIR. One can think of IIR filters basically as DSP versions of analog filters; they can be designed to ensure sharp characteristics, but their drawback is group delay distortion. FIR filters are often used to avoid group delay distortion, although both analog filters and IIR digital filters can be designed to exhibit greatly reduced group delay distortion. In fact, with superior circuit design skills and DSP processing power available, one can design IIR filters with sharp characteristics yet with group delay distortion reduced to the level one finds with FIR filters.

## 2. Transmission

In addition to SSB, CW, FSK and AM modulation, many functions on the TS-870S are performed by DSP. These include microphone audio processing and tone signal generation in FM mode, as well as TX processing in all modes, microphone gain processing, speech processing and VOX.

Moreover, installation of the DSPs has meant that distortion is extremely low, right up to the IF stage. On conventional analog transceivers, by the IF stage distortion can reach fairly high levels and perhaps cause a degradation in sound quality that is irrespective of the IMD level in the final section. On the TS-870S, however, a bipolar final element is employed, ensuring that audio quality on transmit has minimal distortion.

### 1. SSB

SSB modulation on the TS-870S is such that high sideband suppression is achieved for a wider bandwidth. This is because the improved DSP processing capacity has been used to raise the PSN (phase shift network) order to 16. Figure 1 illustrates TX PSN characteristics when the bandwidth is set to 0~3kHz. These characteristics vary in relation to changes in the low-cut frequency, so that even higher sideband suppression is achieved with a low-cut frequency of 500Hz — as illustrated in Figure 2.

As for variation in TX bandwidth, only the LPF for high-cut control is digital on the TS-950SDX, whereas on the TS-870S BPFs are used, and both high-cut and low-cut can be adjusted using digital filters. Figures 3 & 4 illustrate how TX filter shift and width vary.

The SSB monitor is an audio monitor that monitors PSN output in the middle of modulation. As for the distortion that arises prior to the DSPs, accurate monitoring is possible but because the phase is not the same as that of the signal after modulation, a slight difference in audio quality can sometimes be detected.

### 2. CW

Since the TS-950SD, ROM filters have been used for selecting the rise and decay times of CW wave forms. The operator can choose from 4 settings, from short rise times for getting through pile-ups to milder wave forms.

A new feature on the TS-870S is that, if the rise and decay times are set to the longest value (8ms) during full break-in, the decay time alone is reduced to a shorter setting (6ms) thus enabling soft, distortion-free keying during full break-in.

The CW sidetone (monitor signal) is generated by DDS (direct digital synthesizer) under the control of the DSPs. Linked to CW pitch, sidetone production is precisely controlled in the 400Hz to 1kHz range. Strictly speaking, this is not an IF monitor, but since the rise and decay times of the sidetone wave form are regulated in exactly the same way as those of the IF output, the sidetone can be treated as an accurate monitor provided that the ALC meter is working correctly.

### 3. FSK

As with the TS-950SDX, the FSK keying signal is tailored by FIR filters prior to FSK modulation and smooth, accurate keying is assured by DDS under the control of the DSPs. This tailoring of the FSK keying wave form prevents spreading of the spectrum and should thus reduce the error rate at the receiving end.

The TS-870S DDS offers 48-bit quantization under the control of the DSPs; this very high level of quantization means that FSK modulation is performed with accurate and very smooth changes.

For monitoring, the AF FSK is used as it has identical characteristics to the IF FSK.

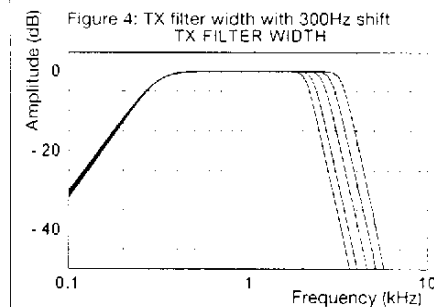
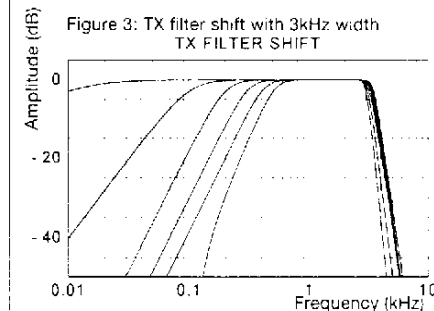
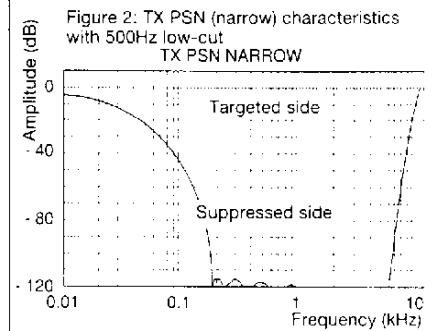
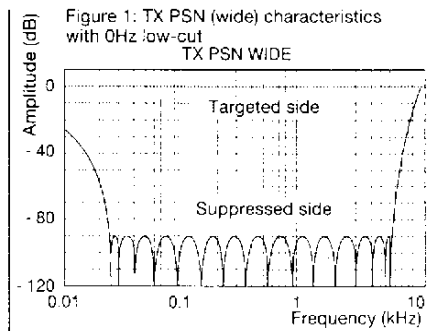

#### **4. AM**

Using AF filters with the same characteristics as those for SSB, audio quality is set, bandwidth limited, and through the DSPs' linear multiplication an amplitude-modulated wave is obtained.

The AM monitor is an audio monitor that monitors the pre-modulation audio. If the ALC setting is correct, this monitor will be accurate.

#### **5. FM**

In FM mode, the DSPs are not used for modulation, but for pre-emphasis filtering and subtone signal generation only.

The signal from the microphone, after passing through the pre-emphasis filter, is governed by the AF AGC so that its level remains slightly below the point at which the limiter operates. This assures modulation of ample depth.

When there are sudden fluctuations in microphone input that cannot be kept below the limiter's threshold by the AGC, the DSP limiter attenuates the signal's amplitude so as to prevent post-modulation bandwidth spread. When the limiter is engaged, a large distortion is generated, but on the TS-870S the limiter's input level is controlled by the AF AGC and thus the limiter operates in fewer instances. With this system even deep modulation of a loud voice gives rise to little distortion from the limiter.

Limiter output is not modulated by the DSPs but instead output as an AF signal and subject to PLL modulation.

The subtone is generated by DDS under the control of the DSPs. For 67~250.3Hz, the DSPs perform FM modulation prior to IF output. For 1750Hz the signal is PLL-modulated together with the modulating wave. The subtone signal that results from digital modulation is stable in terms of both level and frequency, as it is in the case of the TS-850S which also generates a subtone via DDS.

The FM monitor is an AF monitor that monitors the AF output to the PLL. Since it is possible to monitor the sound after it has passed through the limiter, one can also monitor the distortion that sometimes originates in the limiter depending on speech patterns.

#### **6. Microphone gain control**

The microphone gain control in the TS-870S allows digital adjustment of microphone gain. Amplified by approximately 20dB, the mic signal is fed to the DSPs by the A/D converter. It is the DSPs that provide the gain control.

Inside the DSPs, the level of the filtered mic signal is governed by the AF AGC so that it is no more than -12dB with respect to the DSPs' full scale. Microphone gain control is performed by this AF AGC gain adjustment. If the mic gain is set so high that the output level rises above -12dB, it is automatically lowered. The gain adjustment range is 70dB.

The level of -12dB with respect to the DSPs' full scale is the maximum deflection of the ALC meter in SSB mode, and is the maximum modulation level in AM and FM modes. It is also the standard input level for the speech processor in SSB and AM modes.

When the speech processor is switched on in SSB or AM mode, mic gain is fixed at a level that is suitable for most applications and, since gain is not raised unnecessarily there is no distortion.

When the speech processor is switched off in SSB mode, the ALC is adjusted using the mic gain knob. Thus, if mic gain is set low, the AF AGC serves merely as an amplifier, generating no distortion whatsoever. And if there is an input large enough to exceed the ALC's threshold, the ALC is engaged.



## 7. Speech processor

AGC output is fed to the speech processor, where its amplitude is clipped. As the operator, you can choose the compression level (in dB) with reference to the full scale of the DSPs, whose level is limited to -12dB by the AGC. The clipped processor output fluctuates by a maximum of about 9dB with respect to the compression level. In SSB mode, the CAR knob is used to adjust the level fluctuation matched to the analog TX circuitry. In AM mode, by putting the AF AGC on the processor's output side as well, the level is governed so that it does not exceed the set modulation level.

An AF-type speech processor is used on the TS-870S. To many people this may suggest the kind of speech processor that creates a lot of distortion if compression is insufficient. However, the TS-870S DSP "3-band" speech processor offers greater compression and lower distortion than an IF-type speech processor.

The compression method employed is clipping — as with IF-type speech processors. Clipping does give rise to distortion and what can cause a big problem with AF-type speech processors is harmonic distortion. However, if filter bandwidth is no more than an octave, the distortion component will extend beyond that, thus enabling a reduction in harmonic distortion. By dividing up the 3kHz TX bandwidth into 3 octaves, and then clipping and filtering the signal in each of these compartments, thus suppressing distortion, it has been possible to create a low-impedance AF-type speech processor with reduced harmonic distortion. Furthermore, by dividing up the bandwidth finely, intermodulation distortion is lower and so in fact there is less distortion than with an IF-type speech processor.

## 8. VOX

The VOX circuit on an HF transceiver has a function known as ANTI-VOX that prevents unwanted TX activation by RX audio emanating from the speaker.

There is, unfortunately, a problem associated with ANTI-VOX. Since its operation is determined solely by the level of the RX signal entering the speaker, even if the sound from the speaker is not being picked up by the microphone, it may be that transmission is rendered impossible, depending on the ANTI-VOX setting.

On the TS-870S there is much less chance of this occurring because the DSPs perform "correlative" VOX processing. This ensures that VOX sensitivity is lowered, inhibiting transmission, only when it is inferred that the microphone is picking up the RX audio.

## 3. Reception

On the TS-870S, the DSPs are used for detection in all modes — not just SSB, CW and FSK, but also AM and FM. Even automatic gain control is performed by the DSPs.

### 1. SSB

Since even AGC functions are digital on the TS-870S, you are free to expand the bandwidth as much as you like, providing that interference does not become excessive.

Thanks to the combination of PSN that extends as far as the low range, digital filters, and digital AGC, the TS-870S offers a quantum leap in the quality of the received audio compared to conventional transceivers.

With a PSN order of 16, its characteristics are linked to the low-cut frequency of the RX bandwidth. Figure 5 illustrates the characteristics when the low-cut is minimum. More than 90dB of sideband suppression is possible for a very wide

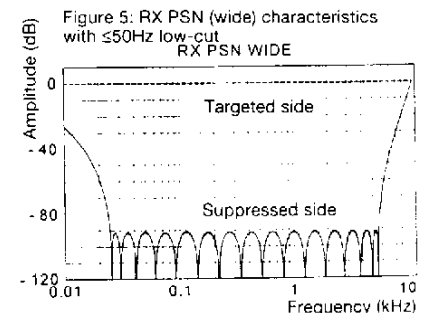

bandwidth of 25Hz to 5.6kHz. When the low-cut frequency is above 500Hz, the PSN bandwidth can be narrow, so for 175Hz to 5.6kHz an even higher sideband suppression is achieved — as illustrated in Figure 6.

Moreover, since frequencies above 5.6kHz are sufficiently attenuated by the IF filters, even with a high-cut frequency of 6kHz there is no interference.

## 2. CW

Apart from filtering, processing is the same as for SSB and FSK modes.

The operator can switch between 6 BPF bandwidths: 50Hz, 100Hz, 200Hz, 400Hz, 600Hz, and 1000Hz. Figure 7 shows how digital filter characteristics vary with changes in WIDTH for a pitch frequency of 800Hz.

The 50Hz and 100Hz BPFs that are not available as analog IF filters are, if improperly designed, likely to generate considerable group delay distortion. The resulting ringing makes reception difficult. Kenwood's DSP design technology, however, has created IF filters that generate less group delay distortion than the previous 250Hz analog filter and have a narrower bandwidth.

As regards release time, the dual-loop digital AGC is far faster than would be possible with an analog AGC. This means that even with fast CW operation, weak signals and noise can be heard in the intercharacter intervals. While some distortion from the AGC is unavoidable with such a short release time, it has been possible to reduce it by using AF BPFs linked to CW band and pitch.

The characteristics of these AF filters have been chosen for a 1dB attenuation at the CW filter cutoff frequency. Processing designed to compensate for the filters' group delay characteristics has greatly suppressed distortion, so there is no drawback from having the AF filters continually active.

## 3. FSK

Apart from filtering, processing is the same as for SSB and CW modes.

The BPFs for FSK use are designed so that the group delay characteristics of their low and high edges — including PSN group delay characteristics — are the same. Any difference between low edge and high edge group delay characteristics will mean that the time it takes to transmit a mark will be different from that required for a space, leading to a higher error rate. The TS-870S avoids this problem by ensuring no difference.

## 4. AM

During AM detection, the amplitude level of the received signal is detected separately for each sampling.

Owing to the fact that neither the rectified nor the square detection performed by analog diodes is linear, distortion is unavoidable. But the DSPs of the TS-870S have linear detection characteristics that enable AM detection with extremely low distortion.

As with PLL detection, which is well known as a low-distortion method for AM, there is no PLL lock failure. This ensures optimum performance whatever the conditions.

The quality of AM reception is, thanks to low-distortion AM detection and FIR filtering in the IF stage, perhaps even superior to that of an audio tuner.

## 5. FM

On the TS-870S, during FM reception also the RX level is governed by the AGC, and detection is performed without using a limiter. At the same time, the operator can choose — via the menu system — to have the S meter act as it does in SSB mode. TS-870S digital FM detection works by computing  $\tan$  of the FM

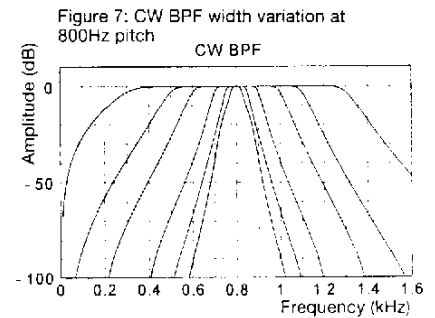
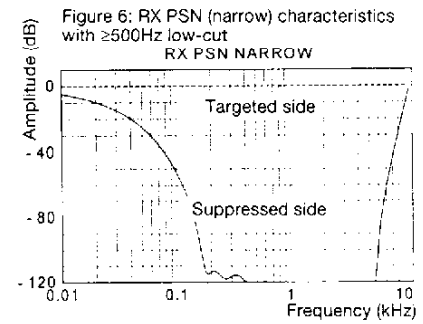

phase change. With this method there is very little variation in detection characteristics as a result of changes in amplitude, and therefore there is no need for a limiter, as required for analog receivers.

While *tan* detection using the DSPs ensures greater linearity in detection characteristics than was possible with analog receivers, FM distortion characteristics are determined not just by detector performance. There is also a considerable effect from IF filter characteristics, and for this reason FIR filters — which are free from group delay distortion — have been used for the IF stage, thus enhancing FM reception.

## 6. Digital AGC

Adopting DSPs for the IF stage of the TS-870S has several benefits, but the key function is digital AGC. This was made possible by using 24-bit DSPs that have a dynamic range of 144dB.

The types of AGC used depend on the mode: dual-loop digital AGC for SSB, CW and FSK modes; effective response digital AGC for AM mode; and average response digital AGC for FM mode.

### 1) SSB, CW & FSK

A digital AGC amplifier is used in the first stage for PSN detection output. The AF signal output by the amp is then detected and controlled by AGC.

As illustrated in Figure 8, the AGC amp implemented via DSP displays characteristics in almost direct proportion to the log within the AGC range. Within the 60dB range of the DSP's AGC, almost one half of the AGC amp's variable gain range — including analog — is taken care of by the DSPs.

AGC attack time can be shortened by reducing the delay time of the loop comprised of the AGC amplifier — IF filters — AGC detection circuit. But if for CW etc. a narrow-band filter is used, the delay time of the IF filters will be increased. This demands a slower attack. On previous analog transceivers, using IF filters with the narrowest band and longest delay time, the attack was adjusted so as to avoid the generation of distortion. But with DSPs, since it is possible to have different attack times for each filter, the shortest attack time that is permitted without distortion is set separately for each filter.

Figures 9 and 10 illustrate AGC attack characteristics in CW mode. In the case of the analog transceiver a pinched “waist” is evident, but in the case of the TS-870S, once past the slight initial jump in amplitude — also visible in Figure 9 — the amplitude is unvarying.

### 2) AM

For AGC detection in AM mode, the DSP's AM output (prior to DC clipping) is integrated to determine the effective value of AM, and then this value is used to perform gain control.

AM detection gives rise to a DC offset, but since this is not required for reproducing the audio component, an HPF is used to clip the DC. However, for AGC it is the audio component which is redundant; the information it requires is in the DC offset, so that is why it is performed prior to DC clipping.

For AM AGC, at the carrier level there is no need for the sort of rapid attack characteristics found in SSB, CW and FSK modes. AGC characteristics are slow attack and slow release, so a single loop is used.

### 3) FM

In FM mode, AGC detection is performed on the output of the digital IF filters. IF filter output is rectified and the integrated signal is then used for gain control.

Figure 8: Digital AGC multiplier

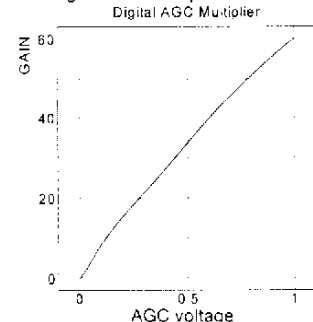

Figure 9: Analog transceiver's attack characteristics

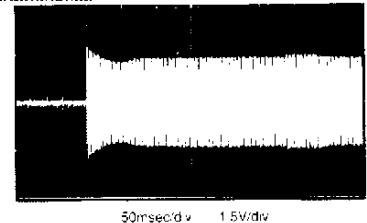
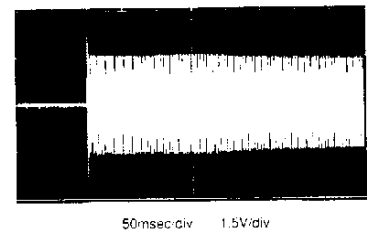

Figure 10: TS-870S attack characteristics



If the AGC is switched off, AGC amplifier gain rises to its maximum level resulting in signal saturation. In the case of analog FM detection, since a limiter is used anyway, this saturation does not pose a problem, but with digital FM detection AGC amplifier saturation gives rise to distortion that in turn gives rise to aliasing distortion. And because this aliasing results in considerable distortion in the FM detection output, AGC is switched on for FM reception.

A fast attack is used for FM AGC, but if the digital AGC amplifier is not saturated and detection is working normally, there is no need for the attack to be as fast as it is for SSB, CW and FSK modes, so AGC is performed with a single loop.

## 4. Noise & Interference Reduction

The noise/interference reduction performed by the DSPs on the TS-870S is not limited to sharp IF filters. Specific measures are taken for noise and beat suppression.

### 1. Noise reduction

#### 1) Line enhancer

A line enhancer is a filter which, using an LMS algorithm, enhances the spectrum of those input signals that display periodicity (see Figure 11). The filter is adaptive, allowing the frequency component of an input audio signal to pass; consequently, frequency components other than the audio frequency are attenuated. And as this filter automatically tracks its target, the signal-to-noise ratio is improved and thus listening becomes much easier.

Figure 12 illustrates a benchmark audio spectrum, while Figure 13 shows the effect of switching the line enhancer on. It is clear how frequency components distant from the RX signal are attenuated.

DSP controls and displays



#### 2) SPAC

In contrast to the line enhancer, which is an adaptive filter that matches periodic signals, SPAC picks out only the periodic signal (see Figure 14). This results in a high signal-to-noise ratio and distinctive audio quality. Because the line enhancer is a filter, it cannot suppress noise that has the same frequency as that of the target signal; however, this is a feat that SPAC can and does perform.

What SPAC does is to compute auto-correlation for the periodic signal, every few periods from the first, and output the result.

With non-complex sounds — in CW mode for example — one can say that the input signal roughly equals the auto-correlation, and thus there is only slight tonal change. But in speech, vowels represent a quasi-periodic signal, and consonants are aperiodic, so correlation processing that targets periodicity will result in unavoidable tonal changes. And although auto-correlation can theoretically eliminate all ambient noise and noise originating inside the transceiver since they are random signals, they do display a very slight periodicity over short intervals of

Figure 11: Line enhancer

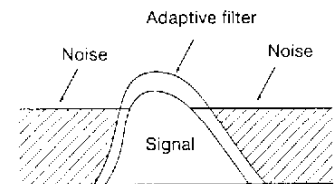

Figure 12: Audio spectrum for reception of 14.2MHz 120dBm signal in SSB mode (line enhancer off)

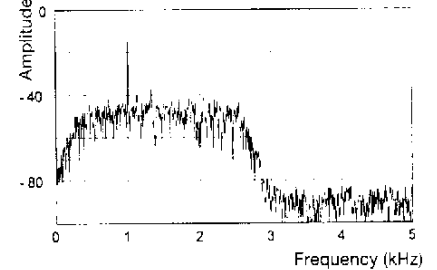

Figure 13: Audio spectrum with line enhancer on

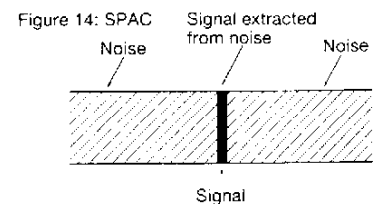
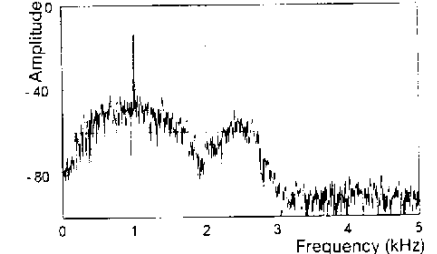

Figure 14: SPAC

the order of 17ms. Periodic components of this noise are what give rise to the typical rumbling sound from the speaker.

In addition to tonal changes there can be another type of noise. Because the output signal is produced by joining together signals computed after the period, if there is any discontinuity at the seams a rustling sound results.

Figure 15 illustrates the effect of having SPAC switched on: the noise level on either side of an RX signal is lowered.

## 2. Auto notch

Since this IF notch filter is inside the AGC loop, switching on the auto notch dampens the beat-induced oscillations of the S meter. At the same time it also brings out signals perceptible in the shadow of the beat so they can be heard clearly.

Based on a type of LMS algorithm called the "stochastic gradient method", this auto notch is an IIR notch filter that automatically tunes to the beat. Since no adjustment is required, rapid response to a sudden QRM is possible.

The way in which the notch filter automatically tracks its target assumes that the beat lies in the direction in which the signal level gets smaller when the null point of the IIR notch filter is shifted. The notch filter frequency characteristics change so precisely that manual adjustment would not be possible. And since there is little group delay distortion, even when the auto notch is active audio reception is only slightly affected.

Because the attenuation possible with a notch filter is theoretically infinite, if it were to tune in exactly onto the beat, even with an S9 or greater signal the S meter would not so much as flicker and the beat would not be heard. In reality, however, the presence of signals other than the beat can reduce the effectiveness of the auto notch so it will not always be so dramatically successful. Nevertheless, beat elimination characteristics are better than ever before.

Figure 17 illustrates the effect of switching auto notch on.

## 3. Beat canceller

Whereas auto notch is part of IF processing, a beat canceller is part of AF processing. This function will not bring out a signal that has been overshadowed by the beat, as the auto notch does, but it can do something else. In contrast to auto notch, which is only effective against a single beat, a beat canceller is effective against multiple beats. Another disadvantage of auto notch is that performance falls off if the beat becomes weaker: tracking slows and the notch may no longer map cleanly onto the beat. Thus, for the kind of weak beat that barely causes the S meter to move, the beat canceller offers better tracking performance and is therefore more effective than auto notch.

The beat canceller is an adaptive filter based on the LMS algorithm. By outputting the difference between the line enhancer output and input signals, it cancels the periodic signal emphasized by the line enhancer from the input signal. Also, the beat canceller does not process the audio as if it were a periodic signal, so no distortion is introduced. As the group delay time of the beat canceller is relatively large, it is not suitable for IF processing. But anyone operating the TS-870S, which features IF processing auto notch, can deal with beat interference efficiently by engaging the auto notch and beat canceller selectively.

Perhaps because these two functions appear to have a similar effect, for some DSP-equipped transceivers the beat canceller is referred to as an auto notch, but for the TS-870S with its digital IF processing we do not use the term "auto notch" to refer to a beat canceller that is unsuitable as an IF notch.

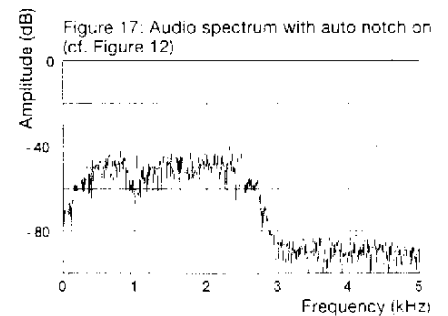
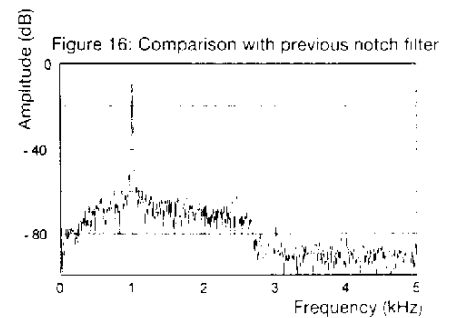
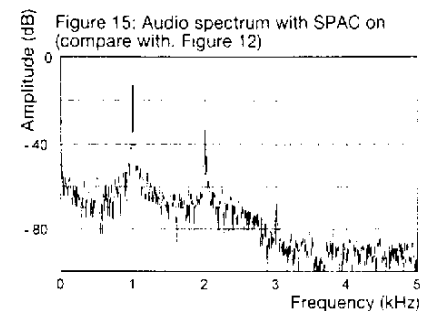
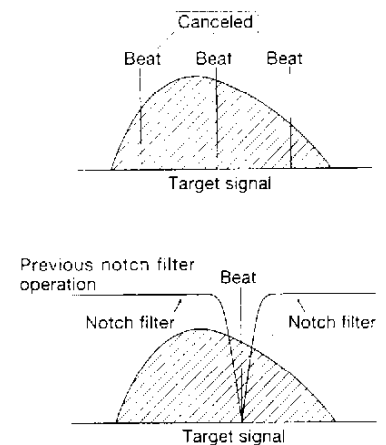

Figure 18: Beat canceller operation



Figures 19 and 20 illustrate the effect of the beat canceller on multiple beat signals.

## 5. RX Circuitry

The TS-870S features high-performance circuitry for DSP-based digital processing from the IF stage onwards. The intermediate frequencies of the quadruple superheterodyne system are as follows: 1st IF 73.05MHz, 2nd IF 8.83MHz, 3rd IF 455kHz, and 4th IF 11.3kHz approx.

You will find a block diagram of the RX section on page 20. The following is an overview of the various parts, presented in the same order as the RX signal is processed.

### 1. Large input protector

This has been installed to provide protection from the sort of large power surge that can threaten the RX section if the transceiver is located too close to a transmitting antenna. If there is a surge the protector is first to blow, thus protecting the important circuitry behind it. Another protector covers the external receiver output terminal.

### 2. External receiver output terminals & signal splitter circuit

The TS-870S features an output terminal for an external receiver that can be placed alongside for simultaneous dual-frequency receive. A signal splitter with wide-bandwidth transformer is used to export a half-voltage RX signal to the external receiver. If a multi-band antenna — such as that used for a tribander — is hooked up, the external unit can receive on a different band at the same time. This is convenient if the operator wants to determine conditions on other bands.

If a TS-870S, TS-950SDX or TS-850S is placed alongside and connected with an interface cable, full TX/RX operation is possible. An interesting application is to use the second unit for the sub-operator in a two-man team. In a contest, you can have the sub-operator search for new stations while you are busy; then, when you are ready to move on, you can have him transfer the next frequency. An added benefit of the signal splitter is that, since the antenna terminals are DC-shortened any surge of static electricity from the antenna is avoided.

### 3. Attenuator

To ensure optimum effectiveness, the attenuator has 3 steps — 6dB, 12dB and 18dB — which can be selected separately for each band and stored in band memory for greater convenience. This is useful for talking to a super-local station or when there is intermodulation interference that the AIP (advanced intercept point) cannot handle.

### 4. Band-pass filters

The BPFs are divided into 11 bands. Since coils with especially high Q are used for the 4-stage 7MHz and 3-stage 14/21MHz filters, they are less prone to intermodulation from broadcast signals, etc. Also, a PIN diode with superior large-input characteristics is used to switch between these filters, so inter-band intermodulation characteristics are further improved.

Figures 21a and 21b illustrate the pass characteristics for the 7MHz and 14MHz BPFs.

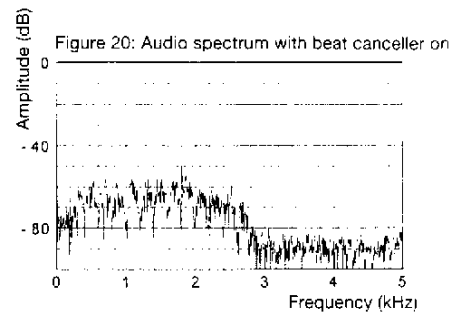
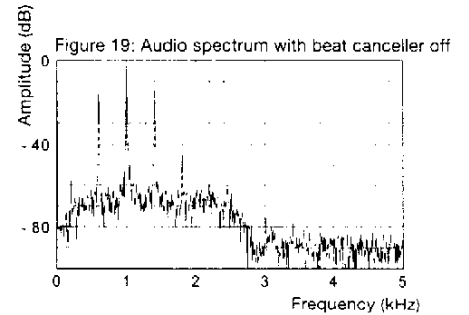

Figure 21a: 7MHz BPF characteristics

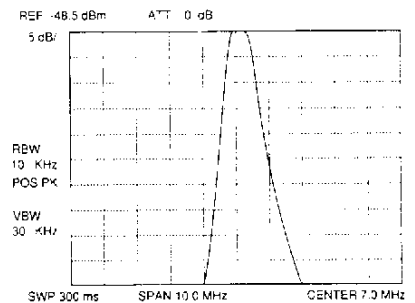
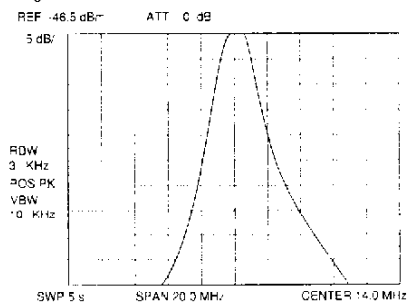

Figure 21b: 14MHz BPF characteristics



## 5. Pre-amps

For bands above 21.49MHz, the TS-870S has a high-gain amplifier (3SK131), while for bands below 21.49MHz, there is a high dynamic range amplifier (2SK2218, parallel). And an AIP function is also available for bypassing these pre-amps.

If the AIP is switched on, the signal is fed directly into the mixer without passing through the pre-amps, but there is still ample sensitivity. In fact, this may be preferable. If the pre-amps only serve to boost gain needlessly, so that a high-level signal is input to the mixer, the result may be to create a ghost signal that will mask the target signal. On the other hand, if you want to listen to a weak signal that is unencumbered by any powerful interference, you can put priority on sensitivity and switch off the AIP to activate the pre-amps.

In good conditions when there are many incoming signals, it is good practice to switch the AIP on; in bad conditions, it should be off. In this way you can get the most out of the preamps.

Figure 22 shows the dynamic range measurements for 2 input signals.

## 6. Mixer

This quad mixer (4 x 2SK520) is of the double-balanced type, ensuring a high intercept point. Here the RX signal is 73.05MHz — the 1st IF.

## 7. Roofing filter

This filter passes only the 73.05MHz IF signal. It improves performance, thus enhancing intra-band intermodulation characteristics and enabling a clean, straightforward catch of the target signal, even when there is band crowding. From here the signal passes to the 1st IF amp and 2nd mixer — changing frequency progressively from 73.05MHz to 8.83MHz, 455kHz and finally 11.3kHz — before being fed into the A/D converter.

## 8. 2nd/3rd IF filters

The IF filters that determine IF selectivity and AGC processing are actually inside the DSPs, but as further protection against interference the TS-870S also uses analog filters. The reason for this is that, however much one improves selectivity with digital filters, if the interfering signal is present before entering the DSPs, the signal will change midway, with the digital filters unable to perform properly. That is why the TS-870S is fully equipped to remove unwanted interference before the signal is fed into the DSPs, where the high-performance digital filters extract any other interference.

## 9. IF amps

The IF amps that operate for each of the intermediate frequencies — 1st IF (73.05MHz), 2nd IF (8.83MHz), and 3rd IF (455kHz) — also implement automatic gain control, using the AGC voltage from the DSPs. While there is digital AGC inside the DSPs, in order to expand AGC dynamic range even further IF gain control is also implemented, as on the previous model.

## 6. TX Circuitry

The TX section uses a quadruple conversion system with the following intermediate frequencies: 1st IF 11.3kHz (approx.), 2nd IF 455kHz, 3rd IF 8.83MHz, and 4th IF 73.05MHz.

The audio signal from the microphone passes through the mic amplifier and into the A/D converter. The resulting digital signal is processed by the DSPs before being changed back to analog form — an IF signal of approximately 11.3kHz — by

Figure 22: Dynamic range

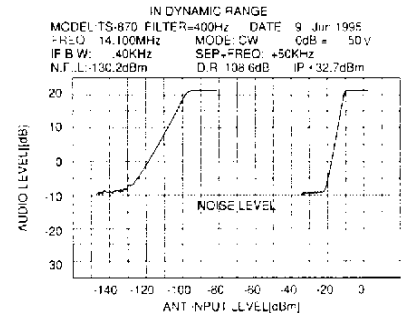

the D/A converter. Subsequent conversions bring the frequency up to 455kHz and then 8.83MHz. It is this signal that is then passed through the same IF filters used for reception, attenuating components outside the bandwidth, and fed into the ALC amplifier.

Following automatic level control, the signal is input into the TX gain control circuit, a newly adopted device for correcting inter-band gain variation from 1.9MHz to 29MHz. Mixed with 64.22MHz, a signal of 73.05MHz is then produced, and this in turn is mixed with the VCO to attain the target frequency. At this point the power level is of the order of 1mW, so it has to be amplified by approximately 50dB in the final unit to 100W. After reducing higher harmonics with the filter unit, the signal is finally output from the antenna terminal.

### 1. TX gain control

This circuit corrects TX gain variation between frequencies over a wide HF bandwidth stretching from 1.9MHz to 29MHz. Because of this wide bandwidth, the frequency characteristics of the final amp, low-pass filter, mixer and other circuits means that some variation in gain from band to band is unavoidable from a design perspective. The TS-870S therefore corrects the difference between each of the bands with the amount of correction stored in the microprocessor. Obviously the correction varies from one transceiver to another, so it is adjusted for each individual unit.

Previously, the operator was forced to re-adjust CAR and mic controls every time the band was changed, so the addition of this new circuit represents a great convenience. Note that, in order to enhance the overall signal-to-noise ratio for the TX section, TX gain control is implemented at the IF stage (8.83MHz).

### 2. TX AGC

In addition to modulation, the DSPs govern the pre-modulation input level. In effect, this is the same as implementing automatic gain control in the mic amplifier, so if the input exceeds a fixed level, amp gain drops correspondingly and the modulator's input level remains steady (processor off). Consequently, even if the microphone gain control is turned up to maximum, modulator input is unaffected.

In FM mode, frequency deviation control is performed by the TX AGC. This prevents any excessive distortion of the type found with the clipper method used previously. In AM mode, control is performed by the DSP in the same way to ensure that modulation does not exceed 70%.

### 3. CW rise time

A switchable CW rise time is available on the TS-870S, as it was on the TS-950SDX. Needless to say, this function controls how long it takes between the actual keying, on the one hand, and the rise and subsequent decay in TX output on the other. A smaller setting ensures a CW wave form with a rapid rise, offering the punch to get through pile-ups; larger settings means a softer, slower wave form. This function too is implemented via DSP processing.

Figures 23a and 23b illustrate its effect.

## 7. Automatic Antenna Tuner

With the TS-870S comes an increase in the number of frequency bands available for storing tuner settings from 11 to 18. The finer division of preset values mean that retuning of the antenna is no longer required when using an antenna with high Q (3.5MHz for example), or when switching from CW to phone in the same frequency band. Care has been taken not to divide the presets too finely, however, as that

Figure 23a: 2ms CW rise time

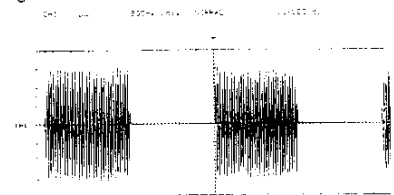
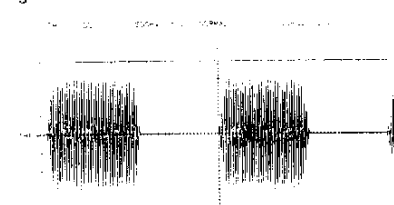

Figure 23b: 8ms CW rise time





would cause the motor to activate with every change in frequency, making the transceiver harder to use.

Another new feature of the TS-870S is the provision of 2 antenna terminals — ANT1 and ANT2 — with different presets for each. Just by tuning each antenna once, optimum settings are ensured simply by switching between them.

When using a long-wire antenna and a Yagi antenna, many interesting possibilities arise if the optional AT-300 is used to combine ANT1 and ANT2 in various ways.

### Example

ANT1: connect to a 1.9MHz long-wire antenna via the AT-300.

ANT2: connect to a 14MHz (Yagi) antenna and use the built-in antenna tuner.

Once tuning is completed for this pair (1.9MHz & 14MHz), you will be using two antenna tuners on 2 antennas, making it easy to switch between them just by changing band.

Automatic antenna tuner controls

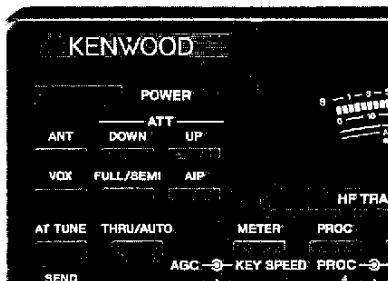

Antenna terminals

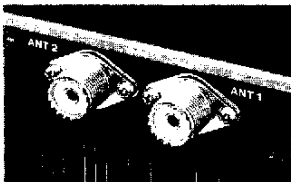

Some operators using the previous model have reported that, when monitoring SWR and thinking that a little more tuning was possible, for some reason the antenna tuner did not stop. To try to alleviate such concerns, the TS-870S menu system allows you to select either the default SWR value of 1.2 or an alternative value of 1.6 for the threshold at which the antenna tuner stops. This choice is available from menu 33: "TUNE WIDE ON/OFF".

The TS-870S also makes possible the use of the antenna tuner during reception. By passing the RX signal through the antenna tuner, the latter effectively works as a filter, protecting against interference from powerful signals in bands adjacent to those used by amateurs.

## 8. DRS (Digital Recording System)

The TS-870S comes equipped (as standard) with a digital recording unit that has an additional channel (4 as opposed to 3 on the previous model) and improved audio quality.

The DRS employs the DAST™ (Direct Analog Storage Technology) system, which uses memory very economically to store high-quality digital recordings. Each of the 4 channels is available for recording messages of up to about 15 seconds, but by combining the 4 channels a maximum of 60 seconds (approx.) of continuous playback is possible.

The digital recording unit features non-volatile memory, so no lithium battery backup is necessary and recorded messages are stored indefinitely, or until re-recorded.

Pressing the REC switch puts the DRS into rec pause mode. In this state, a message can be recorded by continuously depressing the appropriate button (1 to 4) for the desired channel. Recording stops on release of the button, but it also

stops automatically after 15 seconds when the time limit is reached.

Turning the VOX switch on or off allows you to select either monitored playback or TX playback. To start playback, you simply press the appropriate channel switch (1~4). During monitored playback, the monitor knob can be used to adjust audio volume, and if the monitor is switched on it is also possible to monitor playback while the recorded message is being transmitted.

The TS-870S allows continuous playback for, say, a long message that has been recorded in two or more channels, or for repetition of a special message recorded in a single channel. For the former, playback is initiated for the first channel and then, during playback, the switches of the other channels are pressed in sequence. This sort of programmed playback is permitted for 2, 3 or 4 channels (max. 60 seconds).

For repeated playback, the operator can use menu 39 to switch the repeat function on, and menu 40 to set the interval between repetitions. This is especially useful for repeated CQ transmission in a contest.

## 9. Electronic Keyer

The TS-870S is also equipped with a dedicated microprocessor for electronic keying. This is an improved version of the full-featured keyer microprocessor developed by Logikey Corporation, USA.

Among the many settings offered by this microprocessor are CW message record/playback (4 channels), key speed (06~60wpm), automatic contest number generation, and "ultra-speed" (70~990wpm, used for bouncing signals off meteors). It is also extremely simple to change the electronic keyer's functions and operating parameters.

The TS-870S electronic keyer has four main modes: CW message recording, CW message playback, keyer status confirmation, and keyer status configuration (to change functions).

For CW message recording there is a choice of two modes. In real-time mode, the message is recorded and played back exactly as it is typed; in character mode, the dedicated microprocessor plays back each character or word with the correct spacing to enable confirmation during the recording process. Character mode allows you to correct errors during recording.

When recording a message, you must first press the appropriate switch for the desired channel (CH1~CH4) for about 2 seconds. As an indication that the unit is ready to start recording, either a Morse "R" (for real-time mode) or "C" (for character mode) can be heard from the TS-870S's speaker. In character mode, an audible Morse "I" is emitted from the speaker as each character or word is input, confirming that the electronic keyer has received the message. In this mode, it is possible to input the embedded commands listed in Table 2 while recording the message. An embedded command is not treated like the other characters on playback; instead, those words corresponding to the actions described in Table 2 are output. To stop recording, the same channel switch is pressed again.

To play back a CW message, just press the switch for the channel in which it was recorded. And if, during playback, the channel switches are pressed in succession, continuous playback of up to 8 channels is possible.

By leaving the VOX switch on, recorded CW messages can also be transmitted. Playback speed is adjusted using the KEY knob, so you can record a message slowly to ensure accuracy, and then transmit it at a higher speed, matched to the other station.

Depressing channel switches CH3 and CH4 simultaneously causes the microprocessor to output a Morse "?" and enter electronic keyer status confirmation

Controls for digital recording and CW message memory

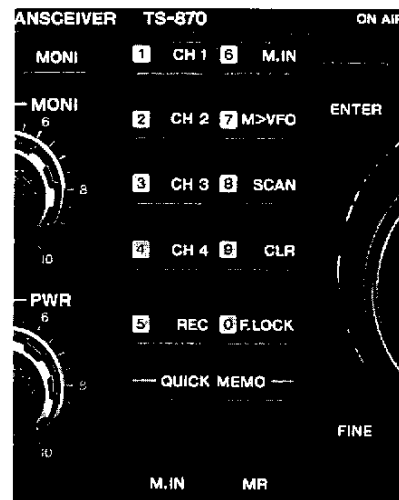

Table 2: Embedded functions

Command	Action
/B	Pause message playback to allow manual text input
/D	Decrease contest serial number by 1
/Gd	Repeat intercharacter or interword spacing equivalent to 7 dots with the equivalent of 3+3 dots. (G0 produces standard intercharacter spacing, while G4 is standard interword spacing)
/N	Play back current contest serial number. The contest serial number is automatically incremented by 1
/Pdd	Insert pause of dd seconds, independent of operating speed
/R	Suspend message playback to permit manual TX. When manual keying is finished, pressing the appropriate channel switch (CH1 / CH2 / CH3 / CH4) will resume transmission of the interrupted message
/Sdd	Set operating speed to dd words/minute, where dd can be 06-90
/Sud	Increase operating speed by d words/minute
/SDd	Decrease operating speed by d words/minute
/Udd	Set ultra-speed for bouncing signals off meteors, where dd can be 07-99, equivalent to 70-990 words/minute
/I	Initiate playback of message in memory 1 following playback of the current message. Ditto for messages 2, 3, and 4 (2, 3 and 4)

Table 3: Inquiry functions

Command	Action
A	Output on/off status of auto space function
C	Output remaining memory available for storing messages
F	Output set function configuration speed (words/minute)
K	Output set keying compensation
L	Output recording mode status (character mode or real-time mode)
N	Output set contest serial number
O	Output hour queue on/off status
S	Output set operating speed
V	Output set electronic over heat
W	Output set weight
Z	Output set option number
1	1 Playback message 1. Ditto for messages 2, 3, and 4

mode. In this mode, it is possible to check on current settings — operating speed, contest serial number, etc. Inputting a command listed in Table 3 will initiate the corresponding action (status confirmation in Morse).

Depressing channel switches CH1 and CH2 simultaneously causes the microprocessor to output a Morse “F” and enter keyer status configuration mode. In this mode, it is possible to change settings for operating speed, recording mode, keyer timing characteristics, etc. Inputting a command listed in Table 4 will enable the operator to change the corresponding setting. You can thus configure the electronic keyer to your own liking.

### Message keyer examples

Messages can be stored as follows:

```
CH1          CQ CQ TEST DE JA1YKX JA1YKX TEST
CH2          UR 5NN/N BK
CH3          BK QSL TU
CH4          QRZ TEST DE JA1YKX TEST
```

And in a contest these would be used as follows:

```
CH1 PUSH    CQ CQ TEST DE JA1YKX JA1YKX TEST
Other station DE JA1ZKN
JA1ZKN CH2 PUSH JA1ZKN (manual) UR 5NNTT1 BK
Other station BK QSL UR 5NNTT1 BK
CH3 PUSH    BK QSL TU
CH4 PUSH    QRZ TEST DE JA1YKX TEST
```

In this way, the only manual keying required is for the 6 characters of the other station’s call number. The advantage of using this electronic keyer becomes especially clear when it comes to incrementing the contest serial number in a DX contest: you can be sure that the correct serial number will always be transmitted. This leaves you free to log the contacts while enjoying the contest.

## 10. Auto Mode

The TS-870S is the first HF transceiver to feature auto mode. This is an enhanced version of the all-mode function used on Kenwood’s TM-255/455 VHF/UHF all-mode transceivers.

What auto mode does is to automatically switch modes if the VFO frequency crosses a set boundary frequency. For example, when operating in various modes in the 14MHz band, you might decide on CW for 14–14.07MHz, FSK (RTTY) for 14.07–14.1MHz, and USB for 14.1–14.35MHz. Auto mode would then ensure that the TS-870S switches to the appropriate mode whenever the frequency changes — a great convenience.

To set the frequencies and modes for auto mode, press the MENU switch while switching transceiver power on and the auto mode configuration menus will appear. The TS-870S uses menus 00~18 to permit a maximum of 19 boundary frequency + mode pairs to be registered, using either the main encoder or the keypad.

Each auto mode frequency that is input represents the upper boundary frequency for the selected mode. For example, let us imagine that in auto mode configuration menu 00 we enter 1.62MHz + AM mode, and in menu 01 we enter 2MHz + CW mode. This means that for frequencies ranging from 30kHz to just under 1.62MHz, the transceiver will be in AM mode; and from 1.62MHz to just under 2MHz it will operate in CW mode (see Figure 24).

Table 4: Function commands

Command	Action
A	Set auto character spacing function
D	Reduce contest serial number by 1
Fdd	Set function configuration speed to odd words/minute
H	Set keyer to hand key mode
K	Increase keying of time, decrease off-time
L	Switch recording mode between character mode and real time mode
Nddd	Increase contest serial number, starting from 1000
Q	Switch if procedure on/off
RV	Reverse dots and dashes
Sdd	Set operating speed to odd words/minute
Sud	Increase operating speed by d words/minute
SDd	Decrease operating speed by d words/minute
Vd	Change voice type (Table 6)
Wdd	Adjust weight to d%
X	Indicate continuous key output to facilitate adjustment of bandwidth amplifier
Z	Set "0" & "9" when transmitting contest serial number

Table 5: Emulation options Command Keyer type

Command	Keyer type
V0	Super Keyer2 with timing coldest memory
V1	Super Keyer2 with timing coldest memory
V2	Super Keyer2 with timing coldest memory
V3	Accukeyer with timing coldest memory
V4	Accukeyer with timing coldest memory
V5	Accukeyer with timing coldest memory
V6	Curtis "A" with timing coldest memory
V7	Curtis "A" with timing coldest memory
V8	Curtis "A" with timing coldest memory
V9	Same as without timing coldest memory

Figure 24: Auto mode example

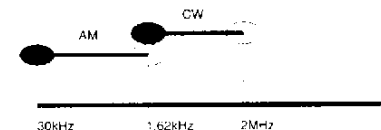

The operator activates auto mode via menu 34 (AUT.MENU). Auto mode then takes control of the main encoder and M.CH/VFO knobs, operating whenever a registered boundary frequency is crossed during program scan. But it does not rob you of your freedom: even when auto mode is on, you can switch to a band of your choosing. Note that if the frequency is changed using the band up/down switch, the last used mode is recalled.

## 11. Data Communications

There is great interest in data communications using HF transceivers. While there is a trade-off between flexibility and speed, this is clearly an exciting new way to explore and expand the world of wireless communications. And it is not limited to RTTY and packet communications: SSTV is also beginning to enjoy a growing following. If you are losing interest in SSB and CW, data communications is certainly something you should try. And the obstacles are rapidly disappearing: one can now buy multi-function TNCs and scan converters capable of being hooked up to a personal computer.

Let's then look at the general categories of data communications and how the TS-870S can be used for them.

For data communications, you use the ACC2 connector (or RTTY connector for FSK mode) on the rear panel of the TS-870S. In addition to TX data input and RX output, the provision of connections for squelch, etc. simplifies operation. It is also possible to switch input and output levels, which used to be troublesome. Menus 20 and 21 allow you to adjust input sensitivity and output level, respectively. Everything has been arranged to help you conduct data communications with the best possible set-up, increasing demodulation efficiency and avoiding splatter.

RX filter bandwidth can be set with slope tuning and menu 19's "PACKET FILTER". And by narrowing the TX filter with menu 29 "TX WIDTH" and menu 30 "TX SHIFT", you can be sure of transmitting a clear signal. Operating ease is further enhanced by putting these menu settings on Menu A and Menu B for simple switching.

## 12. Computer Control

In tune with the computer age, the TS-870S is designed so that virtually all front panel controls can be duplicated by software for full-featured computer operation. Whereas the previous model had a fixed transmission speed of 4,800bps, this transceiver is compatible with speeds of up to 57,600bps, allowing rapid data transfers.

Connecting the TS-870S simply requires a cable to link the transceiver's COM connector with the computer's RS-232C port. The serial data format is 1 start bit, 8 data bits, and 1 stop bit (2 stop bits for 4,800bps). Menu-based speed settings range from 1,200 to 57,600bps.

The commands that are available include exactly the same set used for previous models (TS-950S, TS-850S, and TS-690S/450S, etc.), meaning that the software used with them can also be used to control the TS-870S. However, it is also compatible with new commands that make data communications both easier and more exciting. Of these, the principal ones are listed in Table 8.

Also, in the U.S., where a great deal of software is available for Amateur Radio applications, Kenwood is including a Windows® compatible program for the TS-870S called RCP (Radio Control Program). This displays a graphical representation of the TS-870S front panel on the computer screen, so you can operate the transceiver with just a few mouse-clicks. The sensation is very realistic.

*Note: RCP is compatible with Windows 3.1 and higher.*

Table 6: Data communications categories and the TS-870S

<b>RTTY</b> <b>AMTOR</b> <b>FACTOR</b>	FSK mode is used. Ensuring superior interference reduction are RX filters for each bandwidth (1500Hz, 1000Hz, 500Hz, and 250Hz); interference reduction is great. Of special note is the beautiful TX wave form that is the hallmark of DSP technology.
<b>PACKET</b>	SSB mode is used. Together with the ACC2 terminal on the rear panel. The operator can choose from 3 digital IF filters — 300bps, 1200bps, and FSK — for packet communications.
<b>SSTV</b> <b>FAX</b> <b>CLOVER</b>	As with packet, SSB mode is used. The operator selects IF filters depending on the application — e.g. LC: 500Hz + 4k; 2500Hz for SSTV.

Table 7: Rear panel terminal connections (ACC2 & FSK IN)

Pin	Name	PACKET, SSTV, RTTYC (AFSK) etc.	RTTY, AMTOR, FACTOR	Use	Notes
1	NC				Not connected
2	NC				Not connected
3	AND	AF-OUT	AF-OUT		RX output 302mV/4.7kW
4	SND	GROUND (AF-OUT)	GROUND (AF-OUT)		Shield for AND
5	PSQ	SQUELCH-OUT			Squelch output Clean line Impedance Closed High impedance
6	SMET				Output for 5 meter Not connected
7	NC				Not connected
8	GND	Safety earth	Safety earth		Same as main chassis ground
9	PKS	PKT	PKT		TX for data communications Transmits when started, and stops TX when done This terminal is input
10	NC				Not connected
11	PKR	AREX (Remote)			Microphone input for data communications
12	SND	GROUND (mic)			Shield for PKR
13	SG				Same PTT as front panel terminal
	RTTY KEY		FSK-OUT		Key input for FSK Short: Mark Open: Space
Mode used:		USB, LSB or FM	FM		FSK or FSK-R

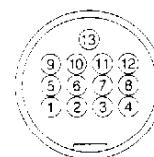

ACC2 connector pin assignments (rear panel)

COM connector

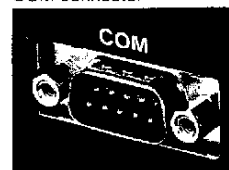
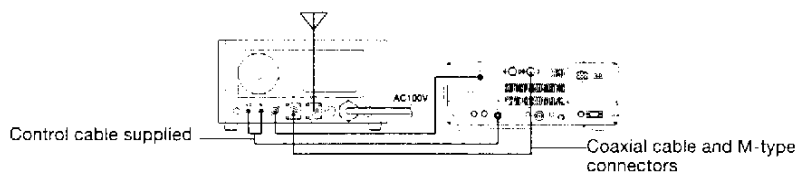

Table 8: Principal new software commands

<b>AI</b> (expansion board)	Auto-information on/off. By switching on auto information (AI) with the AI command, you can check up on changes to set status in real time and in full detail.
<b>EX</b>	Menu setting & read. The EX command can be used to directly change menu settings without engaging menu mode.
<b>KY</b>	Morse conversion & keying. The KY command allows you to type a message on the computer keyboard and have the characters converted into Morse code for output. This function is only possible via computer control.

## 13. Connecting to a Linear Amplifier

The TS-870S can be connected to a linear amp as illustrated:



Menu 51 "LINEAR", which is used for the linear amp control relay, presents a choice of 3 settings — OFF, 1 and 2.

OFF : Do not use linear amp.

1 : Use linear amp.

2 : Use linear amp but with the TX attack time for the 1st key-down delayed by 20ms (CW semi break-in only).

When a linear amp receives the linear on signal from the transceiver, the linear TX/RX relay is activated. Since the linear amp's TX output is very powerful, a correspondingly large device has to be used for the TX/RX relay.

Consequently, the relay is slow to respond and is not immediately activated after receiving the on signal. What this means is that there may be instances when, even though the TX signal is already being output by the transceiver, SWR protection is operative and power output does not rise smoothly. However, selecting "LINEAR 2" mode ensures that, for semi break-in only, the transceiver delays signal output by 20ms on first CW key-down, thus allowing the power to rise smoothly.

## 14. Menu System

As you become more accustomed to operating the TS-870S, you will no doubt begin to think of many different ways in which you would like to use it. That is why Kenwood developed its own menu system for transceivers. Menus allow us to equip the TS-870S with a wide range of selectable functions, without increasing the number of front panel controls.

And there's more. So that the TS-870S is even easier to use, each menu is clearly identified in the 13-segment section on the right of the display. This means that you can make full use of the many convenient functions, without having to pull out the instruction manual each time.

Furthermore, the TS-870S can have two separate configurations, stored as Menu A and Menu B. As an example of how these can be used, you might choose to use Menu A for DX'ing, with a narrower TX bandwidth to ensure your signal has a powerful punch, reserving Menu B for ragchewing, with a wider TX bandwidth to tone down your signal.

Also, if you want to compare your current setup with the default settings, there is even a "menu temporary reset" function available. And since you can control the many DSP-related settings via the menu system, you can create what is for you the optimum TS-870S configuration. Table 10 lists the various functions available through the menu system.

Table 9: 59 standard software commands available

• AC	Antenna tuner in/through & tune on/off setting
• AG	AF gain setting & read
• AN	Switch antenna
• BC	Beat canceller setting & read
• BI	CW break-in setting & read
• BY	Busy signal read
• CG	Carrier gain setting & read
• DN/UP	Same as microphone down/up function
• EQ	TX equalizer setting & read
• FA/FB	VFO A & VFO B frequency setting & read
• FD	RX filter dot data read
• FR/FT	VFO A, VFO B & M channel setting
• FS	Fine function on/off setting & read
• FW	Filter width setting & read
• GT	AGC time constant setting & read
• ID	Set ID code no. read
• IF	Set status read
• IS	IF shift setting & read
• KS	CW keying speed setting & read (For use with RY command)
• LK	Lock on/off setting & read
• LM	DRS recording
• MC	Memory channel setting & read
• MD	Mode setting & read
• MG	Microphone gain setting & read
• ML	TX monitor level setting & read
• MN	TX monitor setting & read
• MR	Memory read
• MW	Memory write
• MX	AIF on/off setting & read
• NB	Noise blanker setting & read
• NL	Noise blanker level setting & read
• NR	Noise reduction setting & read
• NT	Notch filter setting & read
• PB	DRS playback
• PC	TX output setting & read
• PL	Speech processor level setting & read
• PR	Speech processor setting & read
• PS	Power on/off setting & read
• RA	RF ATT setting & read
• RC	RF frequency clear
• RD/RU	RF frequency down/up
• RG	RF gain setting & read
• RM	Meter select & meter read
• RT	RFI on/off setting & read
• RX	Engage RX
• SC	Scan on/off setting & read
• SD	Semi break-in delay time setting & read
• SM	S meter signal output read
• SQ	Squeech level setting & read
• SR	Set reset
• TX	Engage TX
• VD	VOCX delay time setting & read
• VR	Trigger's vocx synthesizer
• VX	VOCX on/off setting & read
• XT	XIT on/off setting & read

Table 10: Menu system

No.	Display	Explanation
00.	MENU.A/B	Switch between Menus A & B. Since A and B are stored as independent configurations, you can tailor the TS-870S for two quite different applications.
01.	AUT/MAN	Auto/manual switch for AGC time constant.
02.	AGC SSB	Set AGC release time for auto (SSB mode).
03.	AGC CW	Set AGC release time for auto (CW mode).
04.	AGC FSK	Set AGC release time for auto (FSK mode).
05.	AGC AM	Set AGC release time for auto (AM mode).
06.	AF.AGC	Set AF AGC release time (the time required for gain to return to normal after being decreased by AGC). In AM and FM modes, this serves to suppress fluctuations in the level of RX signal modulation. With the default setting, it ensures that, even for a signal which exceeds the standard modulation level, audio output will not increase.
07.	AF.AGC.LV	Adjust level at which AF AGC operation starts. Increasing this level will ensure that audio volume is maintained even if the modulation level is small. Can also be switched off.
08.	RX AT	Set antenna tuner circuit on/off during receive. Useful for avoiding interference from a strong signal on adjacent band, etc.
09.	P HOLD	Switch meter peak hold function on/off.
10.	$\Delta$ FREQ	Switch $\Delta f$ display on/off. With TF-SET, enables display of difference between RX frequency and TX frequency ( $\Delta f$ ).
11.	AIP.GAIN	Switch gain compensation on/off (AIP on). Turning AIP on reduces gain for the entire receiver section, but by switching AIP.GAIN on it is possible to restore gain to its original level.
12.	FM.S-MET	FM mode S meter correction. With the TS-870S, AGC is active for all modes, including FM. Thus, in FM mode the S meter responds in the same way as for the other modes. But by switching correction on, the S meter behaves as it would on a dedicated FM transceiver.
<b>DSP functions</b>		
13.	LINE.ENH	Switch line enhancer on/off. When the NR switch is pressed: switching on the line enhancer provides noise reduction via adaptive filters, while switching it off results in noise reduction via SPAC auto-correlation.
14.	LINE.ENH	Set line enhancer tracking speed.
15.	SPAC	Adjust correlation time for SPAC noise reduction. The longer the correlation time, the greater the improvement.
16.	SP.BEAT	Adjust beat canceller tracking time.
17.	SP.NOTCH	Adjust auto notch tracking time.
18.	TRACK	Switch tracking on/off. Tracking can be switched off for adaptive filters such as the line enhancer, beat canceller, and auto notch.
19.	PKT.FIL	Set IF filter for packet use.
20.	PKT.IN	Adjust TX input level from PKD.
21.	PKT.OUT	Adjust RX signal output level from output of ANO.
22.	MIC AGC	Adjust microphone AGC release time (TX).
23.	CW RISE	Set CW rise & decay time. Small values result in crisp tones, while large values produce smoother tones.
24.	PITCH	Set CW pitch. Can be adjusted in steps in the range 400–1000Hz.
25.	PROC.LOW	Adjust low-frequency output for speech processor.
26.	PROC.HI	Adjust high-frequency output for speech processor.
27.	TX INH	Inhibit transmission. Useful when using the TS-870S only as a receiver.
28.	VOX.GAIN	Adjust VOX gain.
29.	TX.WIDTH	TX frequency characteristics: adjust filter bandwidth.
30.	TX.SHIFT	TX frequency characteristics: adjust filter low edge cutoff frequency.
31.	TX.EQ.	Adjust TX frequency equalizer: H (high boost), L (bass boost), or C (comb filter).

AT		
32.	AUTO.RET	Switch antenna tuner auto return on/off. Usually left on, this automatically returns the antenna tuner to RX mode once tuning is finished. If switched off, the tuner does not return to RX mode, but continues to transmit at 10W. Useful when adjusting a linear amp.
33.	TUN.WIDE	Set SWR level at which antenna tuning stops. Usually an SWR of 1.2 or less is sufficient, but if the SWR will not go down that far, the threshold can be raised to 1.6.
Misc.		
34.	AUT.MODE	Switch auto mode on/off. When on, the band is changed automatically depending on the frequency. Useful when set up according to a band plan.
35.	BEEP	Switch beep on/off.
36.	BP.MODE	Configure beep.
37.	WARN.BP	Configure warning beep.
38.	BP.LV	Adjust beep volume.
39.	REPEAT	Switch digital audio memory repeat playback on/off. Use for continual CQ transmission.
40.	REP.TIME	Adjust repeat interval.
41.	F.STEP	Set frequency step corresponding to 1 turn of the main encoder.
42.	BC.STEP	Set click encoder frequency step for medium-wave tuning.
43.	CH.STEP	Set click encoder frequency step.
44.	STEP.ADJ	Alters function of the M.CH/VFO.CH control in VFO mode.
45.	PF.KEY.UL	Assign new function to the ENTER key.
46.	PF.KEY.UR	Assign new function to the TF-SET key.
47.	PF.KEY.LR	Assign new function to the 1MHz key.
48.	PF.KEY.LL	Assign new function to the FINE key.
49.	CH.SHIFT	Switch temporary change to memory contents on/off.
50.	DIMMER	Adjust display brightness (2 levels).
51.	LINEAR	Switch linear amp's TX relay on/off; also adjust delay time (time between relay activation and signal output). OFF: Switch linear amp control relay off. 1: Switch linear amp control relay on. 2: Switch linear amp control relay on; add 20ms to the delay time.
52.	1M/500K	Set frequency step for when MHz key is pressed.
53.	EXT.RX	Switch external RX output on/off.
54.	TRANSFER	Switch split transfer function on/off.
55.	DIRECT	Switch split transfer function on/off directly from VFO during operation.
56.	COM.RATE	Set COM transmission speed (1,200–57,600bps).
57.	SUB.TONE	Switch subtone frequency in FM mode.
58.	SUB.TONE	Switch subtone burst/continuous in FM mode.
59.	FM.BOOST	Switch bass boost on/off in FM mode.
60.	FM.WIDE	Switch wide/narrow in FM mode.
61.	FM.mic	Select microphone sensitivity in FM mode.
62.	FSK.SHFT	Select shift width in FSK mode.
63.	MARK.POL	Reverse key polarity in FSK mode.
64.	FSK.TONE	Change RX tone in FSK mode.
65.	PG.S.HOLD	Switch scan hold on/off for programmed scan.
66.	GRP.SCAN	Switch group scan on/off.
67.	BSY.STOP	Switch busy stop on/off for memory scan.
68.	CAR.SCAN	Switch carrier-operated scan stop on/off for memory scan.

## Appendix

### A/D & D/A converters

For both A/D and D/A conversion, we have equipped the TS-870S with 18-bit converters developed for audio applications. The standard 20MHz clock signal in the TS-870S is used by the PLL in the TX/RX unit to generate a 46.32MHz master clock signal. This is then divided up by an EPM7032LC44 to produce the required timing signals. The sampling frequency is 45.234375kHz, and the IF frequency for both transmit and receive is 11.30859375kHz.

For A/D conversion, an 18-bit  $\Delta\Sigma$  A/D converter is used. Thanks to the combination of 18-bit quantization and the low distortion characteristics of the  $\Delta\Sigma$  A/D converter, the audio signal from the microphone and the IF signal are converted to low-distortion, low-noise digital signals. The digital filter inside the  $\Delta\Sigma$  A/D converter serves to suppress aliasing in a range from 22.6171875kHz (half of the sampling frequency) to approximately 2.87MHz. Consequently, only a simple anti-aliasing filter is required for the A/D converter input.

Similarly, three 18-bit D/A converters are used for D/A conversion. These inexpensive yet high-performance  $\Delta\Sigma$  D/A converters — which have proved their worth in CD applications — ensure low distortion for the TX IF signal and audio output. They too are equipped with digital filters, and aliasing is found at approximately 2.87MHz, far above the audible frequency range. This makes a smoothing filter unnecessary, but filters are needed to suppress noise outside the bandwidth of the  $\Delta\Sigma$  D/A converters.

Finally, an advanced 1-bit D/A converter is employed for the AGC and for FM modulation output. This provides the rapid response necessary for AGC.

### Why a 24-bit DSP?

To raise the performance of an MPU means to process more data and more instructions, and it is true that high-performance numerical processing is demanded of a DSP. By “performance” is meant accuracy of calculation and speed of processing. Moving up from a 16-bit MPU to a 32-bit MPU will indeed achieve this increase in performance, but it must be asked whether it is necessary, for the corresponding cost increase is more than double.

What sort of accuracy is then necessary for a transceiver DSP? It should be sufficient for IF processing with a dynamic range greater than 100dB and, at the same time, ensuring a sufficient signal-to-noise ratio. The dynamic range of a 16-bit DSP is 96dB and, while it may be good enough for detection, it falls short of the requirement for IF processing. A 24-bit DSP, on the other hand, has a dynamic range of 144dB — more than enough for a wide range of applications, including IF and audio processing. Once we reach the 32-bit level, however, we enter the realm of floating point calculation. Here processing capability is such that it becomes meaningless to gauge how many dB the dynamic range would be. And whereas a DSP that performs fixed-point calculations only deals with signals between -1.0 and +1.0, the 32-bit MPU performs like a personal computer, and it is only really needed for the sort of complex applications that are performed on a PC or workstation. In other words, for a transceiver DSP, 32 bits is overkill.



With an MPU processing can be speeded up by increasing the number of bits, because this means it can process more data at a time. In the case of a DSP, however, increasing or decreasing the number of bits will have no effect on processing speed, because it can only process one bit at a time. The only way to speed up a DSP is to increase its MIPS (million instructions per second) rating or increase the efficiency of instruction processing using pipelines, etc.

In conclusion, when deciding whether to use a 16-bit, 24-bit or even 32-bit DSP, the determining factor is not speed but dynamic range. One should choose a DSP that provides sufficient dynamic range for the application and no more. And for IF processing, the correct answer is a 24-bit DSP.

### **Aliasing**

With digital signal processing, the bandwidth of signals that can be handled is limited to half of the sampling frequency. In other words, if the sampling frequency is 10kHz, only signals between 0 and 5kHz can be processed.

In this case, what happens when signals in the range 5-10kHz are fed into the A/D converter? Since they exceed 5kHz, you might expect them to be ignored, but in actual fact 5kHz is not an absolute limit but rather a limit on the bandwidth of the signals that can be processed digitally. Thus we can jump to 5-10kHz and then to 10-15kHz, in increments equivalent to half of the sampling frequency. So if an 11kHz signal is fed in, the A/D converter output is exactly the same as it would be for a 1kHz signal, even though there is no such input. This phenomenon is called "aliasing." Now if both a 1kHz signal and a 11kHz signal are fed simultaneously into the A/D converter, the two cannot be disassociated and thus distortion results. In order to prevent this from happening, an anti-aliasing filter is used to attenuate signal components outside half of the bandwidth deemed necessary for A/D converter input.

# Receiver Section

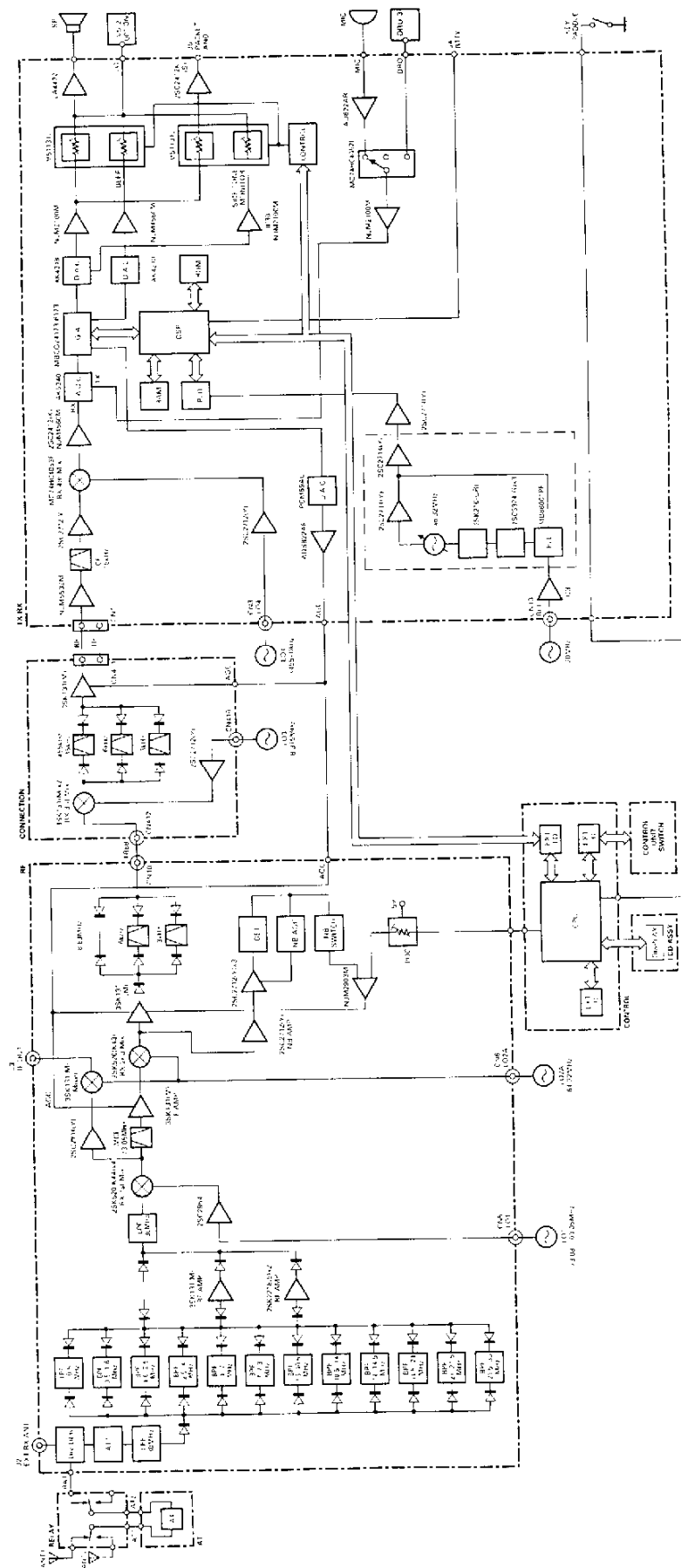

# OPTIONAL ACCESSORIES



**MC-90**  
DSP-Compatible Desktop  
Microphone

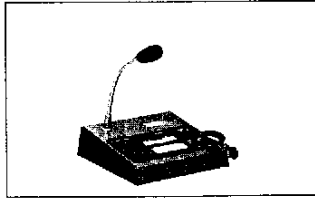

**MC-85**  
Multi-Function Desktop  
Microphone  
(not available in U.S.A. and  
Canada )

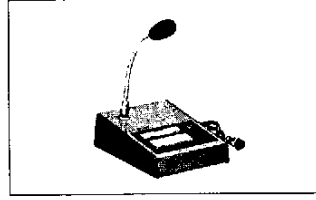

**MC-80**  
Desktop Microphone



**MC-60A**  
Deluxe Desktop Microphone

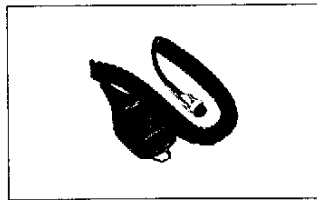

**MC-43S**  
Hand Microphone

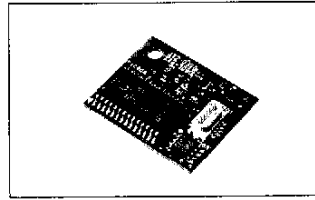

**DRU-3**  
Digital Recording Unit



**PG-2Z**  
DC Power Cable

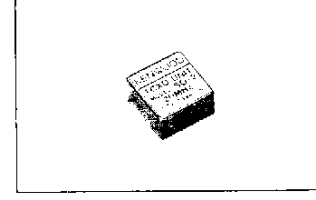

**SO-2**  
Superior Stability TCXO  
(Temperature-Compensated  
Crystal Oscillator)

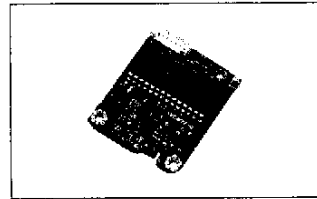

**VS-2**  
Voice Synthesizer

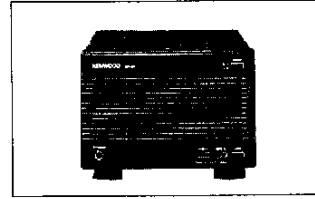

**SP-31**  
External Speaker

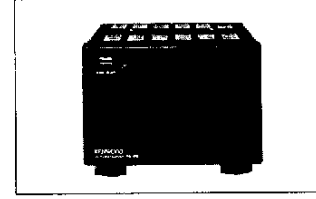

**PS-52**  
Heavy-Duty Power Supply (22.5A)

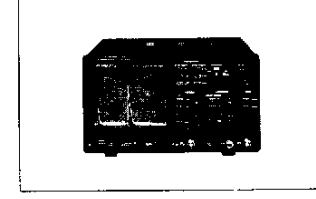

**SM-230**  
Station Monitor

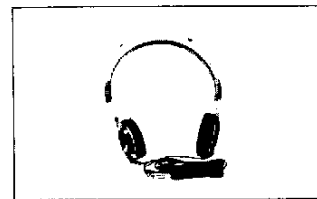

**HS-6**  
Small Headphones (12.5Ω)

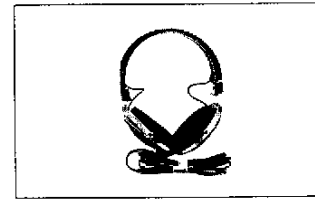

**HS-5**  
Deluxe Headphones (8Ω)

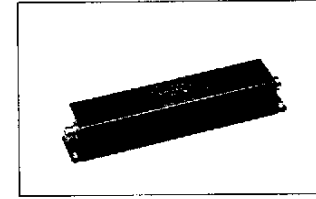

**LF-30A**  
Low-pass Filter

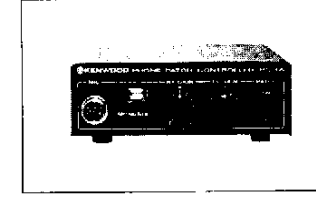

**PC-1A**  
Phone Patch Controller  
(Available only where phone  
patch operation is legal)

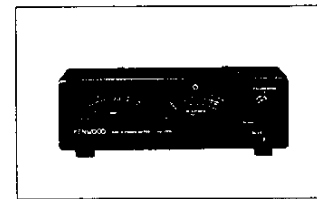

**SW-2100**  
SWR/Power Meter (1.8-30 MHz)

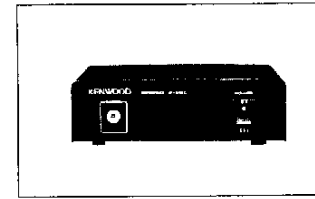

**IF-232C**  
Interface Unit  
(for split transfer using a  
transceiver other than a TS-870S)

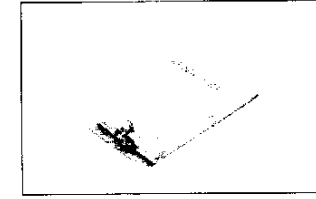

**AT-300**  
Automatic Antenna Tuner  
(not available in U.S.A. and  
Canada )

## **KENWOOD CORPORATION**

14-6, 1-chome, Dogenzaka, Shibuya-ku, Tokyo 150, Japan

### **KENWOOD COMMUNICATIONS CORPORATION**

#### **AMATEUR RADIO PRODUCTS GROUP**

P.O. Box 22745, 2201 East Dominguez St., Long Beach, CA 90801-5745, U.S.A.

Customer Support/Brochures (310) 639-5300

Repair Locations/Parts (800) KENWOOD Bulletin Board Service (BBS) (310) 761-8284

#### **KENWOOD ELECTRONICS CANADA INC.**

6070 Kestrel Road, Mississauga, Ontario, Canada L5T 1S8

#### **KENWOOD ELECTRONICS DEUTSCHLAND GMBH**

Rembrücker Str. 15, 63150 Heusenstamm, Germany

#### **KENWOOD ELECTRONICS BENELUX N.V.**

Mechelsesteenweg 418, B-1930 Zaventem, Belgium

#### **TRIO-KENWOOD FRANCE S.A.**

13 Boulevard Ney, 75018 Paris, France

#### **TRIO-KENWOOD U.K. LIMITED**

Kenwood House, Dwight Road, Watford, Herts, WD1 8EB, United Kingdom

#### **KENWOOD ELECTRONICS ITALIA S.p.A.**

Via G. Sirtori 7/9, 20129 Milano, Italy

#### **KENWOOD IBÉRICA, S.A.**

Bolivia, 239-00020 Barcelona, Spain

#### **KENWOOD ELECTRONICS AUSTRALIA PTY. LTD. (A.C.N. 001 499 074)**

P.O. BOX 504, 8 Figtree Drive, Australia Centre, Homebush, N.S.W. 2140, Australia

#### **KENWOOD & LEE ELECTRONICS, LTD.**

Unit 3712-3724, Level 37, Tower One Metroplaza, 223 Hing Fong Road, Kwai Fong, N.T., Hong Kong

#### **KENWOOD ELECTRONICS LATIN AMERICA S.A.**

P.O. BOX 55-2791, Piso 6 Plaza Chase, Cl. 47 y Aquilino de la Guardia, Panama, Republic of Panama

#### **SINGAPORE REPRESENTATIVE OFFICE**

No. 1 Ganting Lane, # 07-01, Kenwood Building, Singapore 349544